

250 Series - Radius Corners

# UTR760

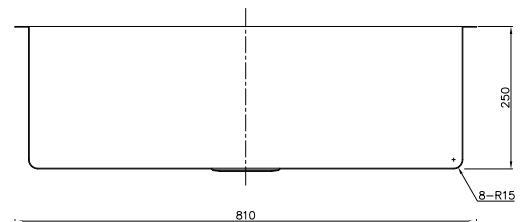

\* Note: Square corner model pictured

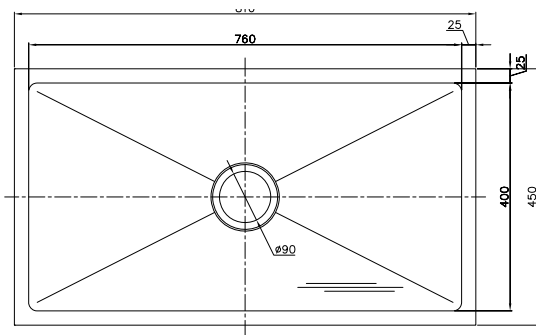

- Suitable for **top-mount** or **under-mount**.
- Made from **1.2mm 18/10** stainless steel.
- Sinks are **250mm deep**.
- Complete with 90mm designer basket waste.
- Alternate sizes available in project quantities.

250 Series - Square Corners

# UTS760

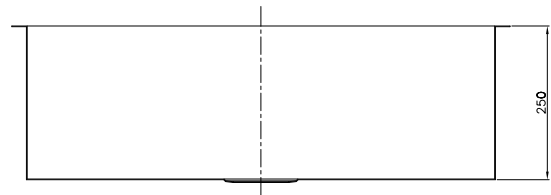
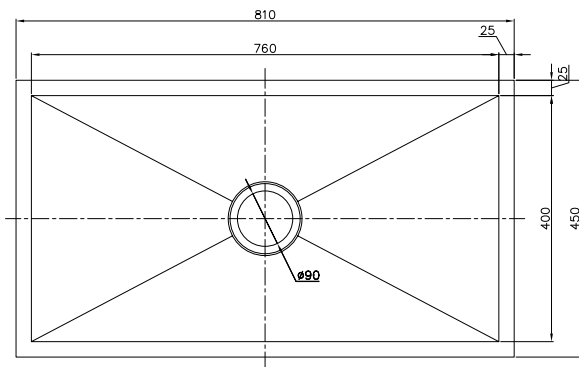

- Suitable for **top-mount** or **under-mount**.
- Made from **1.2mm 18/10** stainless steel.
- Sinks are **250mm deep**.
- Complete with 90mm designer basket waste.
- Alternate sizes available in project quantities.